

PRESSURE SENSOR

For Additional Information See PR-264 Data Sheet

SPECIFICATIONS

Accuracy*: ± 1% FS

Overpressure: 300%

Burst Pressure: 500%

Supply Voltage: 12–40 VDC
 12–35 VAC (VDC output units only)

Supply Current: VDC Units – 10 mA max.
 mA Units – 20 mA max.

Enclosure: 18 Ga C. R. Steel NEMA 4 (IP-65)

Finish: Baked on enamel – PMS2GR88B

EMC Conformance: EN 55022, 55024, 61000-3-3,
 61000-4-2, 3, 4, 5, 6 & 11

Compensated Temp Range: 0°F to 180°F
 (-18°C to 82°C)

T. C. Error: ±0.025%/°F (.03%/°C)

Media Compatibility: Liquid/gases compatible to
 316L stainless steel

Port Connection: 1/8" NPT

Environmental: 10–90%RH Non-Condensing

Termination: Unpluggable screw terminal block

Wire Size: 12 Ga max.

Load Impedance: 3K ohms max. at 40 VDC (mA
 output units)
 1K ohms min. (VDC output units)

Weight: Enclosure 1.0 lbs. (.45 kg)

**Includes non-linearity, hysteresis and non-repeatability*

ORDERING INFORMATION: PR-264-

| RANGE | OUTPUT |
|---|--|
| R1 (psig) 0 to 100 / 0 to 50 / 0 to 25 | mA (4–20 mA 2-wire) |
| R2 (psig) 0 to 300 / 0 to 150 / 0 to 75 | VDC (0–5 VDC/0–10 VDC field selectable) |
| R3 (psig) 0 to 500 / 0 to 250 / 0 to 125 | |
| R4 (kPa) 0 to 700 / 0 to 350 / 0 to 175 | |
| R5 (kPa) 0 to 2000 / 0 to 1000 / 0 to 500 | |
| R6 (kPa) 0 to 3500 / 0 to 1750 / 0 to 875 | |

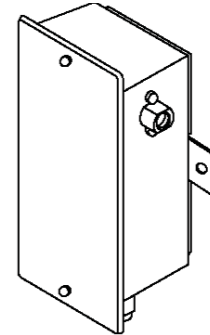

INSTALLATION

Inspection Inspect the package for damage. If damaged, notify the appropriate carrier immediately. If undamaged, open the package and inspect the device for obvious damage. Return damaged products.

- Requirements**
- Tools (*not provided*)
 - Digital Volt-ohm Meter (DVM)
 - Appropriate screwdriver for mounting screws
 - Appropriate drill and drill bit for mounting screws
 - Appropriate accessories
 - Two #8 self-tapping mounting screws (*not provided*)
 - Training: Installer must be a qualified, experienced technician

Warning:

- Do not use on oxygen service, in an explosive/hazardous environment, or with flammable/combustible media.
- Disconnect power supply before installation to prevent electrical shock and equipment damage.
- Make all connections in accordance with the job wiring diagram and in accordance with national and local electrical codes. Use copper conductors only.

Caution:

- Use electrostatic discharge precautions (e.g., use of wrist straps) during installation and wiring to prevent equipment damage.
- Avoid locations where severe shock or vibration, excessive moisture or corrosive fumes are present. NEMA Type 4 housings are intended for outdoor use primarily to provide a degree of protection against wind-blown dust, rain, and hose-directed water.
- Do not exceed ratings of the device.



Mounting

The PR-264 must be mounted on a vertical surface with the 1/8" NPT connection pointed downward. Refer to **Figure 7** for mounting dimensions.

1. Remove the transducer cover using a Phillips head screwdriver.
2. Select the mounting location.
3. Mount transducer on a vertical surface with two #8 self-tapping screws (*not provided*).
4. Pull wires through bottom of enclosure and make necessary connections.
5. Replace the unit cover and make pneumatic connections.

Wiring

Use maximum 12 AWG wire for wiring terminals. Use copper or stainless steel tubing for the connection to the transducer. Refer to **Figures 1, 2, 3, & 4** for wiring information and **Figures 5 & 6** for switch designations.

(Wiring Instructions continued on pages 2 and 3.)



PRESSURE SENSOR

Wiring PR-264 Units with mA Output

PR-264 Pressure Transducer with mA Output

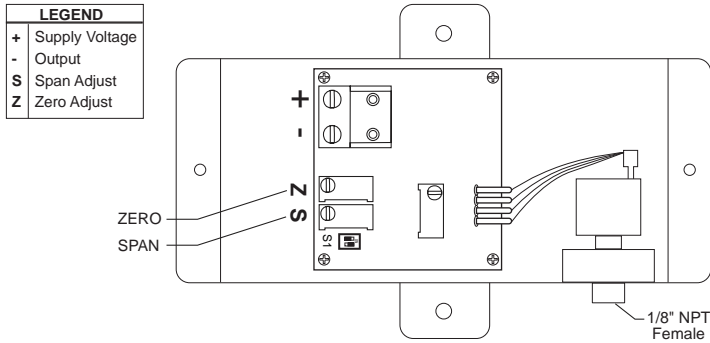

PR-264 pressure transducers with 4–20 mA output units are powered with a 12–40 VDC supply.

The following describes the proper wiring of these pressure transducers with mA output:

1. Remove the terminal block by carefully pulling it off the circuit board.
2. Locate the [+] and [-] terminal markings on the board.
3. Attach the supply voltage to the [+] lead.
4. Connect the 4–20 mA output ([-] terminal) to the controller's input terminal.
5. Ensure that the power supply common is attached to the common bus of the controller.
6. Re-insert the terminal block to the circuit board and apply power to the unit.
7. Check for the appropriate output signal using an ammeter set on DC milliamps connected in series with the [-] terminal.

Wiring PR-264 Units with VDC Output

PR-264 Pressure Transducer with VDC Output

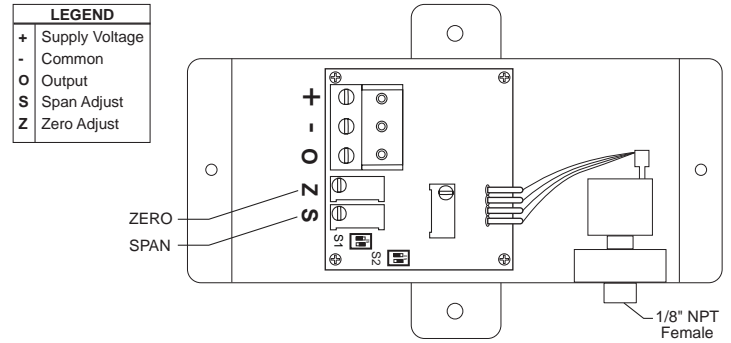

PR-264 pressure transducers with VDC output are field selectable 0–5 VDC or 0–10 VDC output and can be powered with either a 12–40 VDC or 12–35 VAC.

The following describes the proper wiring of these pressure transducers with VDC output:

1. Remove the terminal block by carefully pulling it off the circuit board.
2. Locate the [+], [-] and [O] terminal markings on the board.
3. Attach the power wires to the [+] and [-] terminals. The [-] terminal is also the negative output terminal.
4. Connect the [O] terminal, which is the positive VDC output terminal, to the controller's input terminal.
5. Re-insert the terminal block to the circuit board and apply power to the unit.
6. Check the appropriate VDC output using a voltmeter set on DC volts across the [O] and [-] terminals.

TYPICAL APPLICATIONS (wiring diagrams)

Figure 1 and **Figure 2** illustrate typical wiring diagrams for the PR-264, 4–20 mA, two-wire output pressure transducers.

Figure 1 – Wiring for mA Output Pressure Transducers with an External DC Power Supply

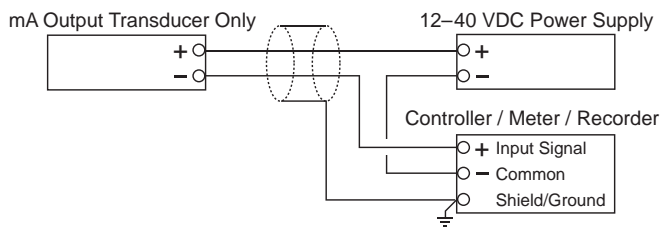
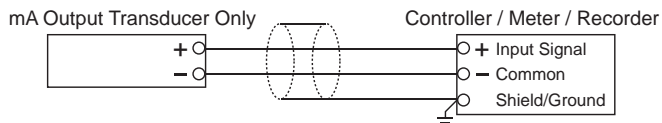

Figure 2 – Wiring for mA Output Transducers where the Controller or Meter has Internal DC Power Supply



TYPICAL APPLICATIONS (wiring diagrams)

Figure 3 and **Figure 4** illustrate typical wiring diagrams for the PR-264, 0–5/0–10 VDC output pressure transducers.

Figure 3 – Wiring for VDC Output Pressure Transducers When Applied with External AC Supply

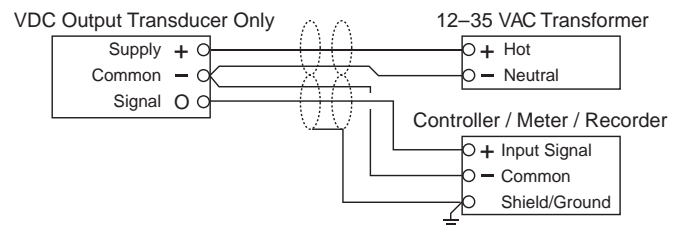
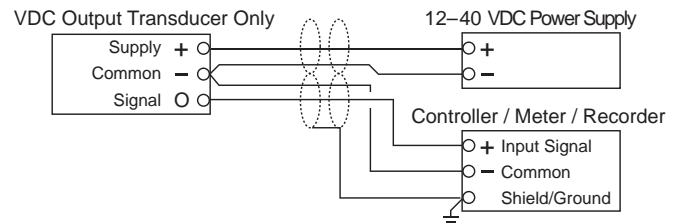

Figure 4 – Wiring for VDC Output Pressure Transducers When Applied with External DC Power Supply



- Caution:** If you are using grounded AC, the hot wire must be on the [+] terminal. Also, if you are using a controller without built-in isolation, use an isolation transformer to supply the PR-264 transducer.
- Caution:** This product contains a half-wave rectifier power supply and must not be powered off transformers used to power other devices utilizing non-insolated full-wave rectifier power supplies.
- Caution:** When multiple PR-264 units are powered from the same transformer, damage will result unless all 24G power leads are connected to the same power lead on all devices. It is mandatory that correct phasing be maintained when powering more than one device from a single transducer.

| Range Configuration: | | Switch 1 (S1) |
|----------------------|-----------------------------------|---------------|
| R1 / R4 | 0–100 psig / 0–700 kPa (default) | |
| | 0–50 psig / 0–350 kPa | |
| | 0–25 psig / 0–175 kPa | |
| R2 / R5 | 0–300 psig / 0–2000 kPa (default) | |
| | 0–150 psig / 0–1000 kPa | |
| | 0–75 psig / 0–500 kPa | |
| R3 / R6 | 0–500 psig / 0–3500 kPa (default) | |
| | 0–250 psig / 0–1750 kPa | |
| | 0–125 psig / 0–875 kPa | |

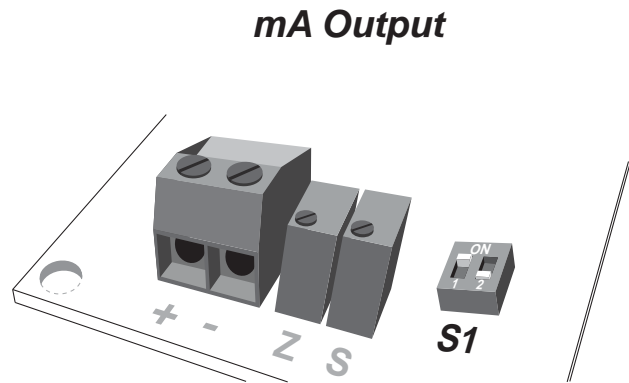
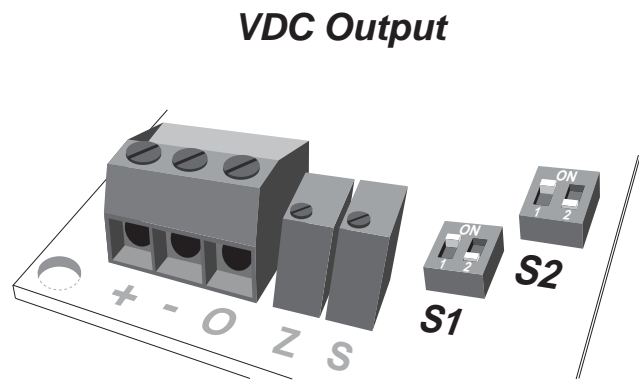

Figure 5 – Range Configurations for Pressure Transducers with mA Outputs

| Range Configuration: | | Switch 1 (S1) |
|----------------------|-----------------------------------|---------------|
| R1 / R4 | 0–100 psig / 0–700 kPa (default) | |
| | 0–50 psig / 0–350 kPa | |
| | 0–25 psig / 0–175 kPa | |
| R2 / R5 | 0–300 psig / 0–2000 kPa (default) | |
| | 0–150 psig / 0–1000 kPa | |
| | 0–75 psig / 0–500 kPa | |
| R3 / R6 | 0–500 psig / 0–3500 kPa (default) | |
| | 0–250 psig / 0–1750 kPa | |
| | 0–125 psig / 0–875 kPa | |



| Output Configuration: | | Switch 2 (S2) |
|-----------------------|--|---------------|
| 0–10 VDC (default) | | |
| 0–5 VDC | | |

Figure 6 – Range Configurations for Pressure Transducers with VDC Outputs



PRESSURE SENSOR

- CHECKOUT**
1. Verify that the unit is mounted in the correct position.
 2. Verify appropriate input signal and supply voltage.



CAUTION: Never connect 120 VAC to these transducers. Never connect AC voltage to a unit intended for DC supply.

3. Verify appropriate configuration range.

Transducer Operation

This is a rough functional check only.

1. Adjust the pressure to obtain maximum output signal for appropriate range.
2. Output should be 20 mA or 5 or 10 VDC.
3. Adjust the pressure to obtain minimum output signal.
4. Output should be 4 mA or 0 VDC.

NOTE: The PR-264 is a highly accurate device. For applications requiring a high degree of accuracy, the use of laboratory quality meters and gauges are recommended.

CALIBRATION All units are factory calibrated to meet or exceed published specifications. If field adjustment is necessary, follow the instructions below.

Calibration of PR-264 mA Units

1. Connect terminals [+] and [-] to the appropriate power source.
2. Connect the DVM in series on the [-] terminal.
3. Apply low pressure to the unit and carefully adjust the zero trimmer [Z] to obtain desired low output.
4. Apply high pressure to the unit and adjust span trimmer [S] to obtain the desired high output pressure.
5. Repeat steps 3 and 4 until desired calibration is achieved.

Calibration of PR-264 VDC Units

1. Connect terminals [+] and [-] to the appropriate power source. The [-] terminal is also the negative output terminal.
2. Connect the DVM on DC volts across [0] and [-] terminal.
3. Apply low pressure to the unit and carefully adjust the zero trimmer [Z] to obtain desired low output.
4. Apply high pressure to the unit and adjust span trimmer [S] to obtain the desired high output pressure.
5. Repeat steps 3 and 4 until desired calibration is achieved.

MAINTENANCE Regular maintenance of the total system is recommended to assure sustained optimum performance.

FIELD REPAIR None. Replace with a functional unit.

WARRANTY See Data Sheet for additional information.

DIMENSIONAL DATA

Figure 7 – PR-264 Pressure Transducer dimensions shown in inches and millimeters (mm).

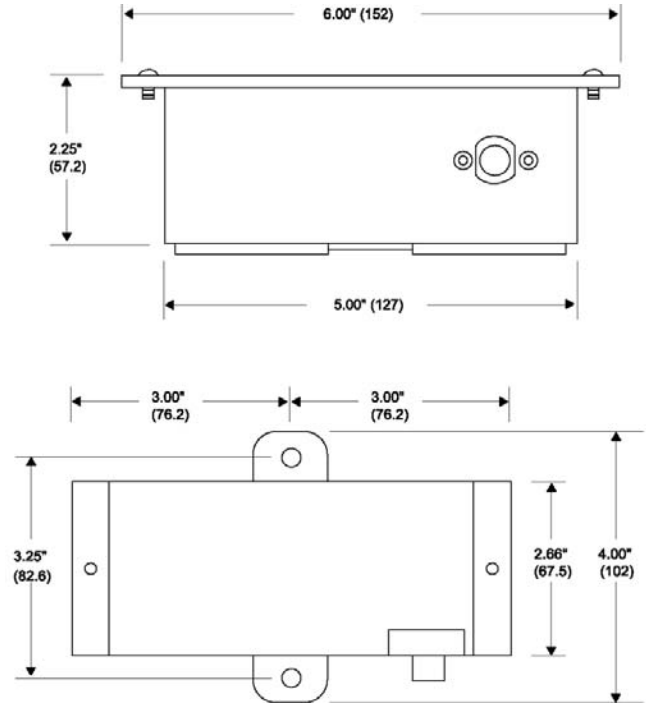

For Technical / Application Assistance call your nearest office

MAMAC SYSTEMS®

8189 Century Boulevard • Minneapolis, MN 55317-8002 • USA
 800-843-5116 • 952-556-4900 • Fax 952-556-4997
 sales@mamacsys.com • www.mamacsys.com

EUROPE

4200 Waterside Centre
 Solihull Parkway
 Birmingham • West Midlands
 B37 7YN • United Kingdom
 01384-271113 • Fax 01384-271114

CANADA

675 Cochrane Drive
 East Tower • 6th Floor
 Toronto • Ontario
 L3R 0B8 • Canada
 905-474-9215 • Fax 905-474-0876

ASIA

1 Fullerton Road #02-01
 One Fullerton
 Singapore • 049213
 65-31581826 • Fax 65-31581826

AUSTRALIA

4 Armiger Court, Unit 2
 Adelaide • S.A.
 5088 • Australia
 08-8395-4333 • Fax 08-8395-4433

MAMAC Systems, Inc., reserves the right to change any specifications without notice to improve performance, reliability, or function of our products.