

Current Switches



Model CT-800/805/810/815



- Available in two transformer core configurations: solid or split-core for ease of installation
- Two trip set point options are available: fixed or adjustable
- LED indication for load status and current flow
- Switch output is rated for up to 135 VAC/VDC
- UL listed and CE certified

CT-800 series Current Switches provide a reliable and low cost solution to monitor status of supply/exhaust fans, pumps, compressors, unit ventilators, lighting or any other equipment consuming current. CT-800 solid-core and CT-805 split-core have a fixed set point and will switch on if the load/current exceeds 0.5 Amp. The fixed set point can be lowered to 0.250 Amp with two turns through the C.T. or 0.125 Amp with four turns. CT-810 solid-core and CT-815 split-core have an adjustable set point of 1 to 200 Amps. Trip set point can be easily field adjusted by turning a trimmer. LED indication is provided to show status. All 800 series Current Switches are rated to switch up to 1.0 Amp @ 35 VAC/VDC or 0.35 Amp @ 135 VAC/VDC eliminating the need and expense of an in line relay or load interlock. 5 year warranty, UL listed, CE certified and the lowest cost in the industry are some of the features which make the 800 series an ideal solution for load status monitoring and alarming functions.



8189 Century Boulevard • Minneapolis, MN 55317-8002 • USA
800-843-5116 • 952-556-4900 • Fax 952-556-4997
sales@mamacsys.com • www.mamacsys.com

4200 Waterside Centre
Solihull Parkway
Birmingham • West Midlands
B37 7YN • United Kingdom
01384-271113 • Fax 01384-271114

1 Fullerton Road #02-01
One Fullerton
Singapore • 049213
65-31581826 • Fax 65-31581826

4 Armiger Court, Unit 2
Adelaide • S.A.
5088 • Australia
08-8395-4333 • Fax 08-8395-4433

675 Cochrane Drive
East Tower • 6th Floor
Toronto • Ontario
L3R 0B8 • Canada
905-474-9215 • Fax 905-474-0876

CT-800/805/810/815

SPECIFICATIONS:

Supply Voltage: Self-Powered

Isolation Voltage: 1000 VAC

Frequency Range: 45/65 Hz

Operating Temp: 32°-158°F (0-70°C)

Environmental: 10-90% RH, Non-Condensing

Termination: Terminal Block 14 Ga max

Agency Approvals: UL listed, CE certified

Max. Switching Current: 1.0 Amp @ 35 VAC/VDC
0.35 Amp @ 135 VAC/VDC

Housing: UL 94-V-0 Flame retardant ABS Plastic

Fixed Set Point: 0.5 Amp

Adjustable Set Point: 1.5 to 200 Amps

Weight: .25 lb (.11 kg)

CONFORMANCE & TESTING:

RoHS Compliant

EMC Testing:

BS EN 55022:1998, BS EN 55024:1998,
EN 61000-3-3, EN 61000-4-2,
EN 61000-4-3, EN 61000-4-4,
EN 61000-4-5, EN 61000-4-6,
EN 61000-4-11

ORDERING INFORMATION:

Model	Description
CT-800	Solid-core fixed set point
CT-805	Split-core fixed set point
CT-810	Solid-core adjustable set point
CT-815	Split-core adjustable set point

CAUTION: Do not use in explosive/hazardous environment.

CT-800/805/810/815

CT-800 / CT-810 Solid Core

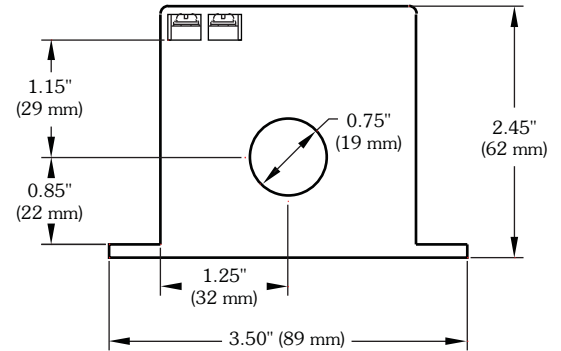
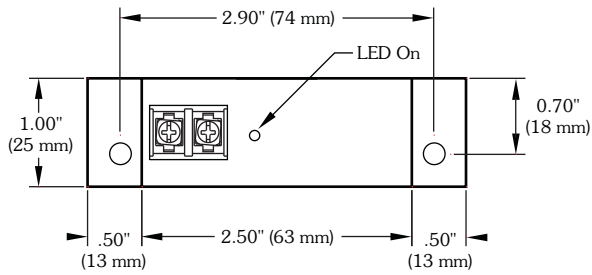

CT-805 / CT-815 Split Core

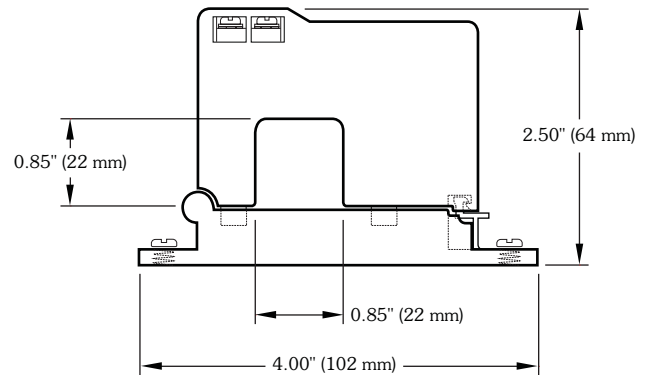
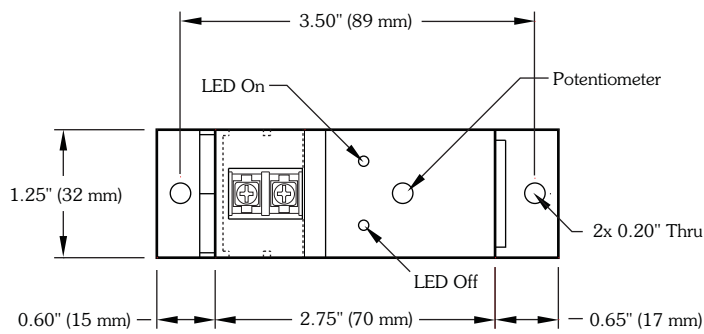

CT-800/805/810/815

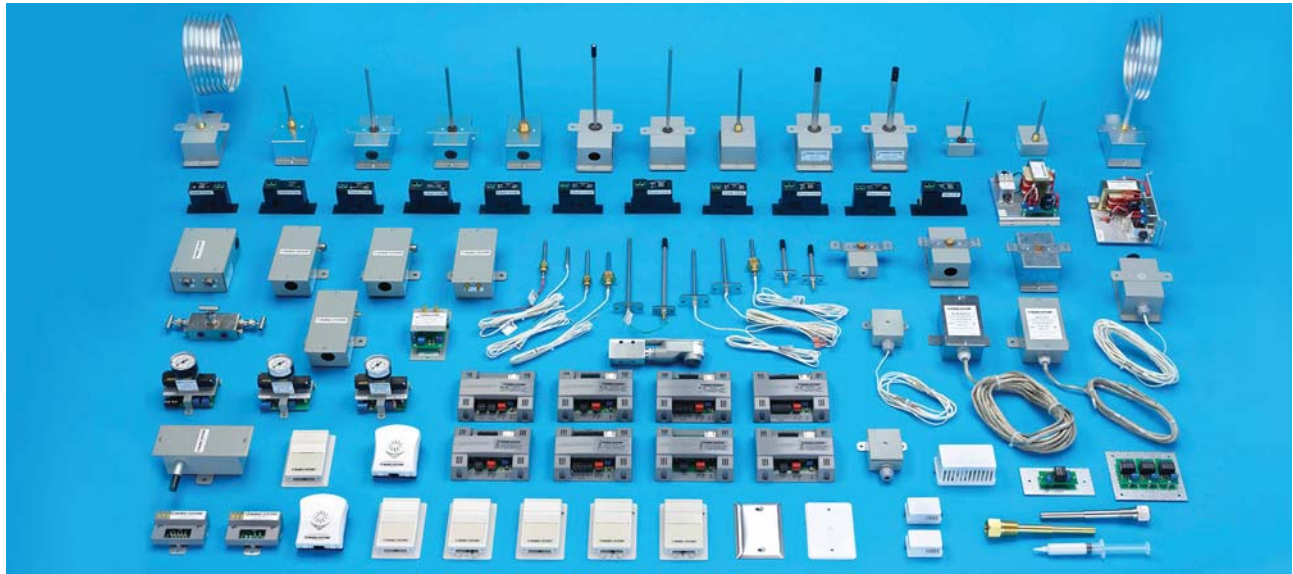

MAMAC Systems is the leading global manufacturer of sensors, transducers, control peripherals and web browser based IP appliances. MAMAC products are used for HVAC and environmental controls, remote monitoring, alarming, energy metering and industrial automation.

All MAMAC products are manufactured in the USA.

WARRANTY: MAMAC Systems, Inc. and its subsidiaries (hereinafter referred to as MAMAC Systems) warrants its products to be free of defects in material and workmanship for a period of five (5) years from date of shipment. If a unit is malfunctioning, it must be returned to the factory for evaluation. A return authorization number (RMA) will be issued by the customer service department and this number must be written or prominently displayed on the shipping boxes and all related documents. The defective part should be shipped freight pre-paid to the factory. Upon examination by MAMAC Systems, if the unit is found to be defective, it will be repaired or replaced at no charge to the customer. However, this warranty is void if the unit shows evidence of being tampered with, damaged during installation, misapplied, misused, or used in any other operating condition outside of the unit's published specifications.

MAMAC Systems makes no other warranties or representations of any kind whatsoever, expressed or implied, except that of title. All implied warranties including any warranty of merchantability and fitness for a particular purpose are hereby disclaimed. User is responsible to determine suitability for intended use.

LIMITATIONS OF LIABILITY: The remedies of buyer set forth herein are exclusive and the total liability of MAMAC Systems with respect to this order, whether based on contract, warranty, negligence, indemnification, strict liability or otherwise, shall not exceed the purchase price of the product upon which liability is based. **In no event shall MAMAC Systems be liable for consequential, incidental or special damages.** MAMAC Systems reserves the right to change any specifications without notice to improve performance, reliability, or function of our products.

Every precaution for accuracy has been taken in the preparation of this manual, however, MAMAC Systems neither assumes responsibility for any omissions or errors that may appear nor assumes liability for any damages that result from the use of the product in accordance with the information contained in the manual.



8189 Century Boulevard • Minneapolis, MN 55317-8002 • USA
800-843-5116 • 952-556-4900 • Fax 952-556-4997
sales@mamacsys.com • www.mamacsys.com

4200 Waterside Centre
Solihull Parkway
Birmingham • West Midlands
B37 7YN • United Kingdom
01384-271113 • Fax 01384-271114

1 Fullerton Road #02-01
One Fullerton
Singapore • 049213
65-31581826 • Fax 65-31581826

4 Armiger Court, Unit 2
Adelaide • S.A.
5088 • Australia
08-8395-4333 • Fax 08-8395-4433

675 Cochrane Drive
East Tower • 6th Floor
Toronto • Ontario
L3R 0B8 • Canada
905-474-9215 • Fax 905-474-0876